



DIVAN D'EXAMEN ÉLECTRIQUE  
POWER EXAMINATION COUCH

**quest**<sup>®</sup>



Version : 09-2015



# quest®

## LA RÉFÉRENCE DES DIVANS À HAUTEUR VARIABLE THE REFERENCE FOR POWER COUCHES

### CONFORT COMFORT

- Largeur utile 100 % de la sellerie
- Mouvements électriques doux
- Possibilité de combiner pédale et commande manuelle (3 connections)
- 100 % of the surface usefull
- Smooth electrical motions
- 3 connections possible (possibility to combine hand and foot control)

### HYGIÈNE / HYGIENE

- Système Block'n Roll exclusif (modèles 2050-15/30/50)
- Toutes les parties exposées sont accessibles au nettoyage
- Revêtement avec protection antibactérienne (suivant choix de couleur, voir nuancier)
- Exclusive Block'n Roll system (models 2050-10/30/50)
- All exposed parts are cleanable
- Covering with antibacterial protection (depending on the color, see color chart)



Modèle présenté avec options/accessoires  
Products shown with options/accessories

### SÉCURITÉ SAFETY

- Pied en H très stable
- Capacité 200 kg
- Proclive - Déclive (sur certains modèles)
- Sellerie non-feu M1 (suivant choix de couleur, voir nuancier)
- Bras d'élévation robustes
- Very stable H shaped base
- 200 kg patient weight capacity
- Trendelenburg - reverse trendelenburg (on specific models only)
  - M1 fire retardant upholstery (depending on the color, see color chart)
  - Sturdy elevation arms

### ACCESSIBILITÉ ACCESSIBILITY

- Hauteur variable de 54 à 94 cm
- Compatible avec un lève-malade
- Variable height from 54 to 94 cm
- Compatible with a hoist



Accueil  
Welcome



Position haute  
High position



Examen général  
General examination



Déclive  
Trendelenburg



Proclive  
Reverse trendelenburg

CARACTÉRISTIQUES STANDARD - modèle 2050-10

STANDARD FEATURES - model 2050-10

Hauteur variable électrique de 54 à 94 cm  
 Structure acier avec finition époxy gris nuage  
 Dossier réglable par vérin à gaz ou vérin électrique  
 Commande manuelle  
 Patins de réglage sous piètement  
 Block'n Roll® - Système de roulettes escamotables intégrées semi-centralisé (réf : 2050-15, 2050-30 et 2050-50)  
 Support rouleau papier (longueur maxi 50 cm - ø 12,5 cm)  
 12 cm de dégagement au sol compatible avec le passage d'un lève-personne  
 Connexion de 3 commandes possible  
 Capacité de charge jusqu'à 200 kg  
 (testé en dynamique à 250 kg et en statique à 800 kg)  
 Dispositif médical de classe électrique 2 / Disponible en classe 1 avec option 2059-01, non compatible avec 85114-01

Electric variable height from 54 to 94 cm  
 Steel frame structure with grey epoxy finish  
 Gas-spring assisted or electric backrest  
 Hand control  
 Adjustable levlers under base  
 Block'n Roll® - Integrated retractable castor system semi centralized (ref: 2050-15, 2050-30 and 2050-50)  
 Paper roll holder (max length 50 cm - ø 12,5 cm)  
 Mobile hoist compatibility clearance of 12 cm  
 Possibility of 3 control connections  
 200 kg patient weight capacity  
 (tested at a dynamic weight of 250 kg and a static weight of 800 kg)  
 Electrical medical device class 2 / Available in class 1 with option 2059-01, not compatible with 85114-01

Modèles Models	Patins	Levellers	Block'n Roll®	Proclive / Déclive Tredenlenburg Reverse tredenlenburg	Dossier à gaz Gas-spring assisted backrest	Dossier électrique Electric backrest
2050-10	●				●	
2050-15			●		●	
2050-20	●			●	●	
2050-30			●	●	●	
2050-50			●	●		●

### Selleries Upholstery

Tous modèles, à commander séparément / All models, to order separately

**PLATE FLAT**



Largeur / Width 65 cm..... 600150-65  
 Largeur / Width 75 cm..... 600150-75

**A BOURRELETS LATERAL PADDINGS**



Largeur / Width 65 cm..... 600151-65  
 Largeur / Width 75 cm..... 600151-75

**ANATOMIQUE FORMED**



Largeur / Width 73 cm..... 600150-70

### Options\*

\* A demander impérativement lors de la commande, montage usine / Plant installed, must be ordered with initial order

**81036**



4 roues à frein double galet ø 50 mm  
 Set of 4 double castors with brakes ø 50 mm  
 (réf./ref: 2050-10, 2050-20)

**2231-65** **2231-75**



Sellerie/upholstery 65 cm    Sellerie/upholstery 75 cm  
 Trou pour visage  
 Face cutout in head cushion  
 uniquement sur sellerie plate  
 only with flat upholstery  
 600150-65 / 600150-75

**600000-01**



Montage de sellerie en usine  
 Factory assembly fitting of upholstery

**2092**



Batterie  
 Battery

### Accessoires Accessories

**166**



Paire d'étaux  
 Pair of clamps

**840+166**



Paire d'appui-jambes  
 Pair of legrests

**850+166**



Paire d'étriers  
 Pair of stirrups

**985-01+166**

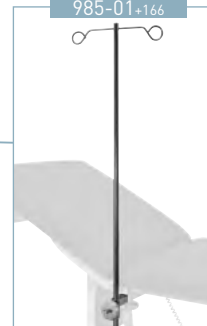

Tige porte-sérum  
 2 crochets  
 2 hook IV pole

**2985-01+166**



Tige porte-sérum autobloquant 2 crochets  
 Auto-locking 2 hook IV pole

**861**



Paire de housses pour appui-jambes  
 Pair of covers for legrests

**2536+166**



Appui-bras (unitaire)  
 Armrest (unit)

**2537**



Housse pour appui-bras (unitaire)  
 Cover for armrest (unit)

**2054-01**



Appui-tête compatible avec sellerie uniquement  
 Headrest compatible with formed upholstery only

**2055-01**



Rallonge de dossier non compatible avec sellerie anatomique  
 Backrest extension not compatible with formed upholstery

**1102-10**

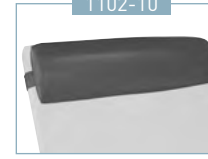

Appui-tête  
 Headrest

**2051-10**



Commande par pédale  
 Foot control  
 (réf./ref: 2050-10 + 2050-15)

**2051-20**



Commande par pédale  
 Foot control  
 (réf./ref: 2050-20+2050-30)

**2051-30**



Commande par pédale  
 Foot control  
 (réf./ref: 2050-50)

**2056-02**



Porte-rouleau réglable  
 Adjustable paper-roll holder  
 (350-800 mm)

**85114-01**



Paire de barrières  
 Pair of barriers  
 Non compatible avec les accessoires / Not compatible with accessories  
 166, 985-01, 2985-01

**Lampes Lamps + 166**

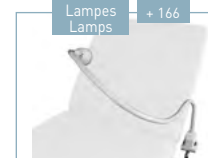

Se référer à la documentation  
 Refer to the literature

Choix de selleries non-feu M1  
Antibactérien  
Choice of M1 fire retardant  
and antibacterial upholstery

Classic

- 32 - BLEU / BLUE
- 93 - COTTAGE / COTTAGE
- 35 - ROUGE / RED
- 34 - JAUNE / YELLOW
- 91 - BLANC / WHITE
- 92 - MARINE / MARINE
- 56 - OBSCURE / DARKNESS
- 57 - ANTISTATIQUE / ANTISTATIC  
Non classé M1 / Not classified M1

Vitamin

- 64 - RAISIN / GRAPE
- 67 - LAGON / LAGOON
- 66 - BONBON / SWEET
- 63 - CEDRAT / CEDRAT

Cosy

- 80 - CIEL / SKY
- 81 - VERT D'EAU / SEA GREEN
- 65 - LILAS / LILAC
- 96 - ETAIN / TIN
- 82 - GRIS SOURIS / MOUSE GREY
- 83 - NATUREL / NATURAL
- 84 - CHOCOLAT / CHOCOLATE

Selleries RITTER  
RITTER upholstery  
Non classé M1  
Not classified M1

- C1 - NAVY
- C2 - DUSTY BLUE
- C3 - MOSS

ANTIBACTÉRIEN / NON FEU M1 - ANTIBACTERIAL / M1 FIRE RETARDANT



Poids net  
Net weight  
Divan / Couch 83 kg  
Sellerie / Upholstery 21 kg

Poids brut  
Gross weight  
Divan / Couch 121 kg  
Sellerie / Upholstery 25 kg

Volume  
Divan / Couch 0,96 m<sup>3</sup>  
Sellerie / Upholstery 0,28 m<sup>3</sup>

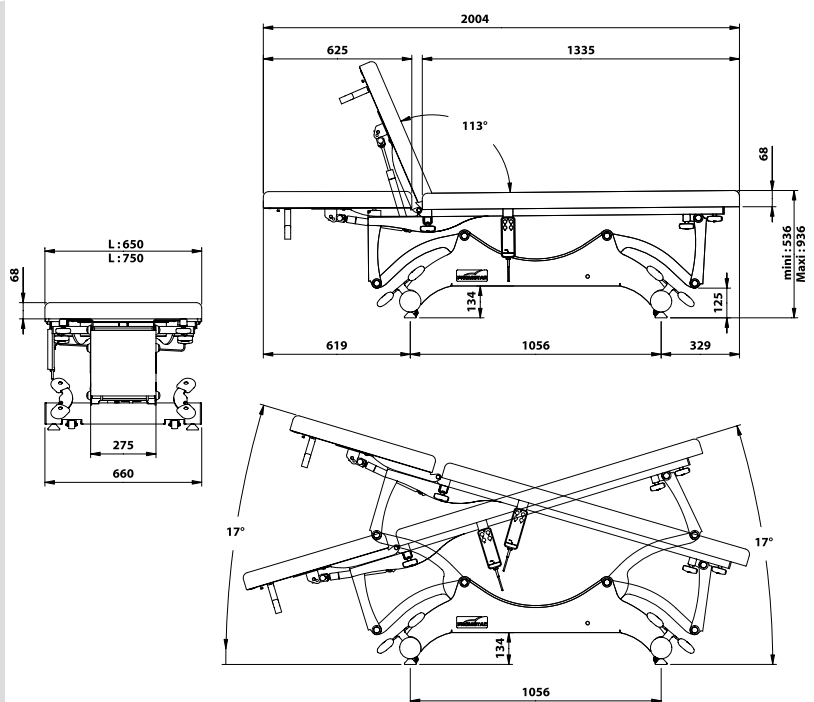

FE-38/15

